

## Curved Tunnel Slides

### DEINOX RRK-35-2z1000-90 H1800

- Made of stainless steel AISI 304.
- Structure designed to be mounted to a tower/platform.
- On request it can be adapted for installation on an embankment.
- Recommended mounting height 1.55m – 1.80m.
- The inner surface of the slide is entirely an usable area.
- The slide has been designed in accordance with the EN 1176-3:2017-12 standard.
- 5-year warranty.

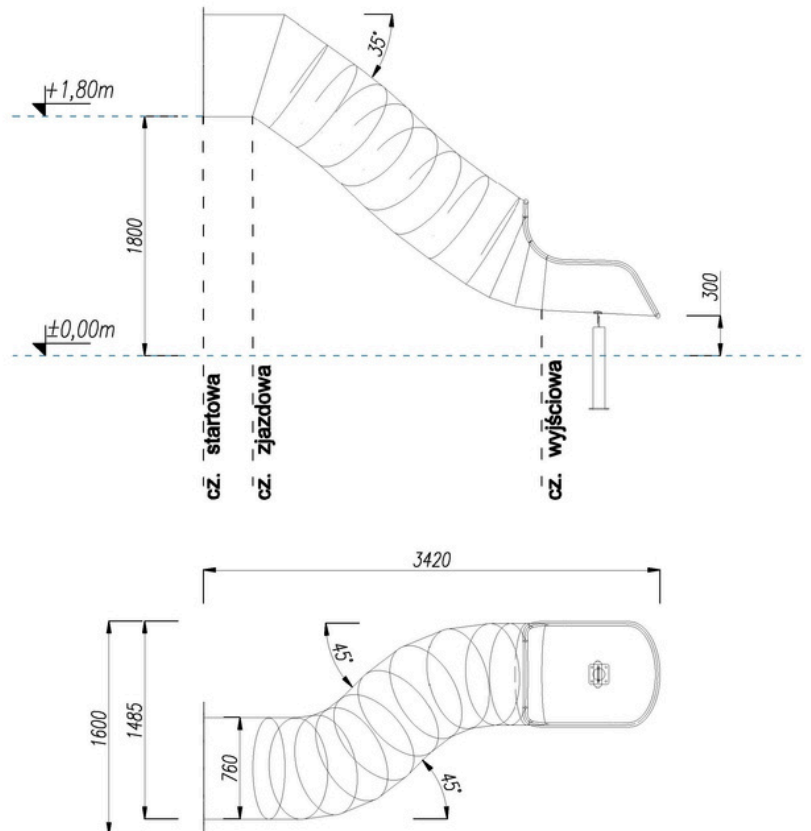

<b>H - Effective height</b>	1,80 m
<b>D - Effective diameter of slide</b>	0,76 m
<b>L - Effective length</b>	4,077 m
Length of the starting section	0,370 m
Length of the sliding section	2,837 m
Length of the exit section	0,870 m
<b>Type of exit section according to EN 1176-3:2017-12</b>	Type 2
<b>Max slope of descent</b>	35°

Design by DEINOX. Copying and distributing the content of the project or any part of it without the author's written consent is prohibited.