

Curved Tunnel Slides

DEINOX RRK-35-2z1350-90 H3500

- Made of stainless steel AISI 304.
- Structure designed to be mounted to a tower/platform.
- On request it can be adapted for installation on an embankment.
- Recommended mounting height 3.25m – 3.50m.
- The inner surface of the slide is entirely an usable area.
- The slide has been designed in accordance with the EN 1176-3:2017-12 standard.
- 5-year warranty.

H - Effective height	3,50 m
D - Effective diameter of slide	0,77 m
L - Effective length	8,028 m
Length of the starting section	0,370 m
Length of the sliding section	5,888 m
Length of the exit section	1,770 m
Type of exit section according to EN 1176-3:2017-12	Type 2
Max slope of descent	35°

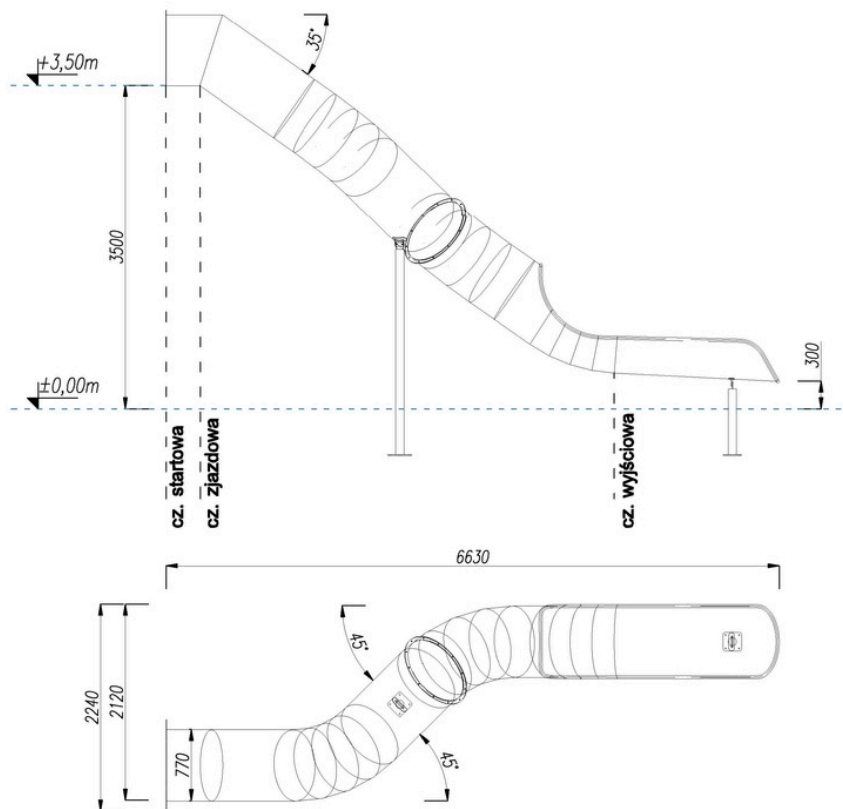

Design by DEINOX. Copying and distributing the content of the project or any part of it without the author's written consent is prohibited.