

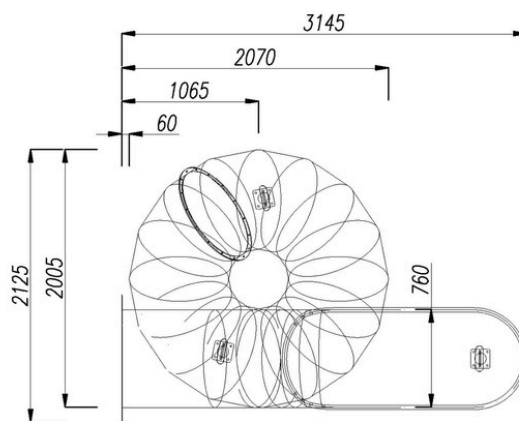

Spiral Tunnel Slides

DEINOX RRS-27-620-360 H2600

- Made of stainless steel AISI 304.
- Structure designed to be mounted to a tower/platform.
- Recommended mounting height 2.42m - 2.67m.
- The inner surface of the slide is entirely an usable area.
- The slide has been designed in accordance with the EN 1176-3:2017-12 standard.
- 5-year warranty.

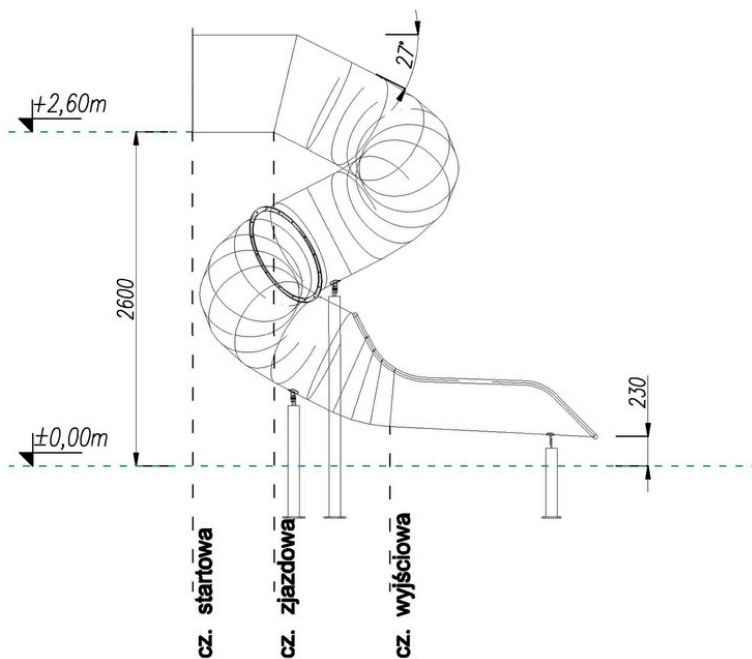

H - Effective height	2,60 m
D - Effective diameter of slide	0,76 m
L - Effective length	7,555 m
Length of the starting section	0,635 m
Length of the sliding section	5,320 m
Length of the exit section	1,600 m
Type of exit section according to EN 1176-3:2017-12	Type 2
Max slope of descent	27°

Design by DEINOX. Copying and distributing the content of the project or any part of it without the author's written consent is prohibited.