

Spiral Tunnel Slides

DEINOX RRS-29-750-360 H3400

- Made of stainless steel AISI 304.
- Structure designed to be mounted to a tower/platform.
- Recommended mounting height 3.18m - 3.43m.
- The inner surface of the slide is entirely an usable area.
- The slide has been designed in accordance with the EN 1176-3:2017-12 standard.
- 5-year warranty.

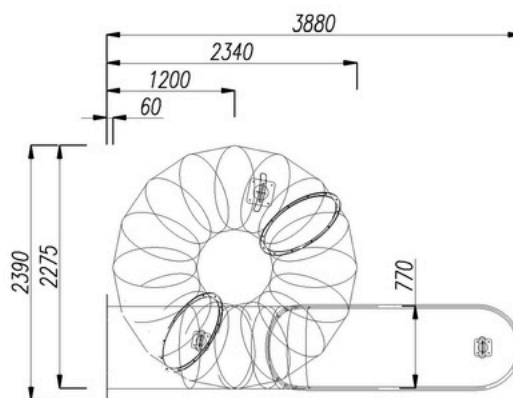
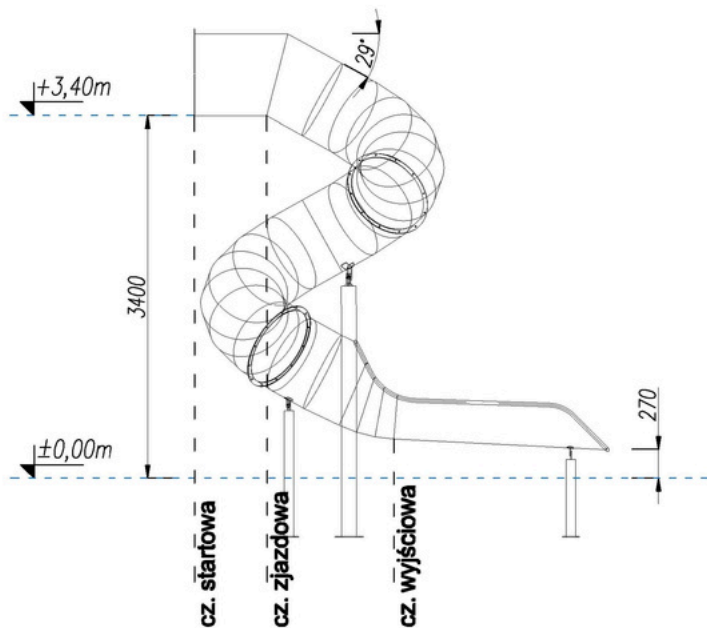

H - Effective height	3,40 m
D - Effective diameter of slide	0,77 m
L - Effective length	9,323 m
Length of the starting section	0,680 m
Length of the sliding section	6,643 m
Length of the exit section	2,000 m
Type of exit section according to EN 1176-3:2017-12	Type 2
Max slope of descent	29°

Design by DEINOX. Copying and distributing the content of the project or any part of it without the author's written consent is prohibited.