

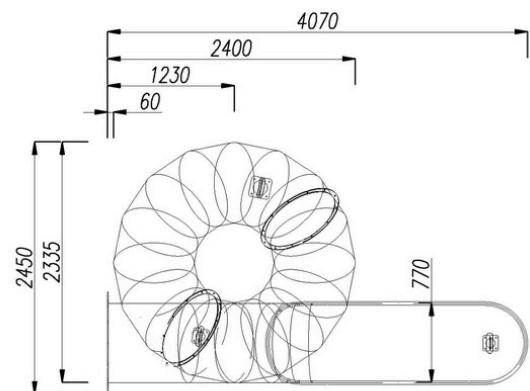

Spiral Tunnel Slides

DEINOX RRS-30-780-360 H3700

- Made of stainless steel AISI 304.
- Structure designed to be mounted to a tower/platform.
- Recommended mounting height 3.47m - 3.72m.
- The inner surface of the slide is entirely an usable area.
- The slide has been designed in accordance with the EN 1176-3:2017-12 standard.
- 5-year warranty.

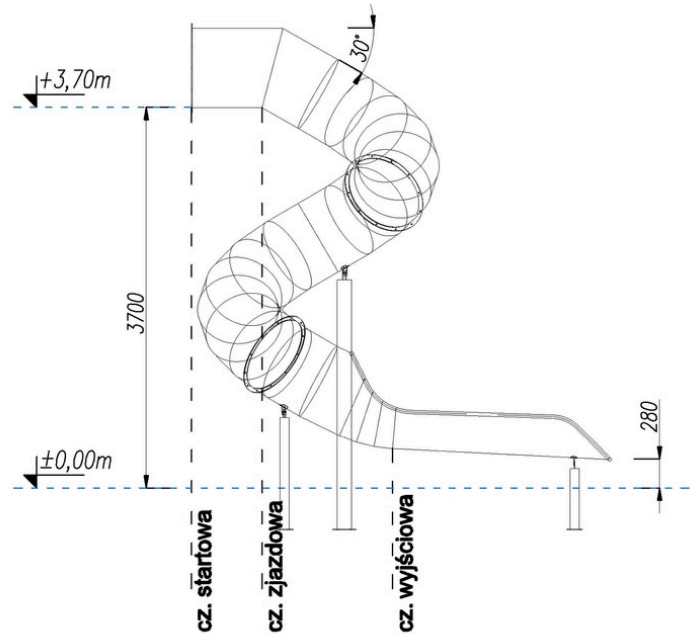

H - Effective height	3,70 m
D - Effective diameter of slide	0,77 m
L - Effective length	9,806 m
Length of the starting section	0,685 m
Length of the sliding section	7,011 m
Length of the exit section	2,110 m
Type of exit section according to EN 1176-3:2017-12	Type 2
Max slope of descent	30°

Design by DEINOX. Copying and distributing the content of the project or any part of it without the author's written consent is prohibited.